

## Package leaflet: Information for the user

**ALPROLIX 250 IU powder and solvent for solution for injection**  
**ALPROLIX 500 IU powder and solvent for solution for injection**  
**ALPROLIX 1000 IU powder and solvent for solution for injection**  
**ALPROLIX 2000 IU powder and solvent for solution for injection**  
**ALPROLIX 3000 IU powder and solvent for solution for injection**

eftrenonacog alfa (recombinant coagulation factor IX, Fc fusion protein)

**Read all of this leaflet carefully before you start using this medicine because it contains important information for you.**

- Keep this leaflet. You may need to read it again.
- If you have any further questions, ask your doctor, pharmacist or nurse.
- This medicine has been prescribed for you only. Do not pass it on to others. It may harm them, even if their signs of illness are the same as yours.
- If you get any side effects, talk to your doctor, pharmacist or nurse. This includes any possible side effects not listed in this leaflet. See section 4.

### **What is in this leaflet**

1. What ALPROLIX is and what it is used for
2. What you need to know before you use ALPROLIX
3. How to use ALPROLIX
4. Possible side effects
5. How to store ALPROLIX
6. Contents of the pack and other information
7. Instructions for preparation and administration

#### **1. What ALPROLIX is and what it is used for**

ALPROLIX contains the active substance eftrenonacog alfa, recombinant coagulation factor IX, Fc fusion protein. Factor IX is a protein produced naturally in the body necessary for the blood to form clots and stop bleeding.

ALPROLIX is a medicine used for the treatment and prevention of bleeding in all age groups of patients with haemophilia B (inherited bleeding disorder caused by factor IX deficiency).

ALPROLIX is prepared by recombinant technology without addition of any human- or animal-derived components in the manufacturing process.

#### **How ALPROLIX works**

In patients with haemophilia B, factor IX is missing or not working properly. This medicine is used to replace the missing or deficient factor IX. ALPROLIX increases factor IX level in the blood and temporarily corrects the bleeding tendency. The Fc fusion protein in this medicine increases the length of time that the medicine works.

## **2. What you need to know before you use ALPROLIX**

### **Do not use ALPROLIX**

- if you are allergic to eftrenonacog alfa or any other ingredients of this medicine (listed in section 6).

### **Warnings and precautions**

Talk to your doctor, pharmacist or nurse before using ALPROLIX.

- There is a small chance that you may experience an anaphylactic reaction (a severe, sudden allergic reaction) to ALPROLIX. Signs of allergic reactions may include, generalised itching, hives, tightness of the chest, difficulty breathing and low blood pressure. If any of these symptoms occur, stop the injection immediately and contact your doctor. Because of the risk of allergic reactions with factor IX, your initial administrations of ALPROLIX should be performed under medical observation where proper medical care for allergic reactions can be provided.
- Talk to your doctor if you think that your bleeding is not being controlled with the dose you receive, as there can be several reasons for this. For example, the formation of antibodies (also known as inhibitors) to factor IX is a known complication that can occur during the treatment of haemophilia B. The antibodies prevent the treatment from working properly. This would be checked by your doctor. Do not increase the total dose of ALPROLIX to control your bleed without talking to your doctor.

Patients with a factor IX inhibitor may be at an increased risk of anaphylaxis during future treatment with factor IX. Therefore, if you experience allergic reactions such as those described above, you should be tested for the presence of an inhibitor.

Factor IX products may increase the risk of unwanted blood clots in your body, especially if you have risk factors for developing blood clots. Symptoms of a possible unwanted blood clot may include: pain and/or tenderness along a vein, unexpected swelling of an arm or leg or sudden shortness of breath or difficulty breathing.

### Cardiovascular events

If you have been told you have heart disease or are at risk for heart disease, take special care when using factor IX and talk to your doctor.

### Catheter-related complications

If you require a central venous access device (CVAD), risk of CVAD-related complications including local infections, presence of bacteria in the blood and catheter site blood clots should be considered.

### Documentation

It is strongly recommended that every time ALPROLIX is given, the name and batch number of the product are recorded.

### **Other medicines and ALPROLIX**

Tell your doctor or pharmacist if you are using, have recently used or might use any other medicines.

### **Pregnancy and breast-feeding**

If you are pregnant or breast-feeding, think you may be pregnant or are planning to have a baby, ask your doctor or pharmacist for advice before taking this medicine.

### **Driving and using machines**

ALPROLIX has no influence on the ability to drive and use machines.

### **ALPROLIX contains sodium**

This medicine contains less than 1 mmol sodium (23 mg) per vial that is to say essentially “sodium free”. In case of treatment with multiple vials, the total sodium content should be taken into consideration.

### **3. How to use ALPROLIX**

Treatment with ALPROLIX will be started by a doctor who is experienced in the care of patients with haemophilia. Always use this medicine exactly as your doctor has told you (see section 7). Check with your doctor, pharmacist or nurse if you are not sure.

ALPROLIX is given as an injection into a vein. You or somebody else may administer it after receiving adequate training. Your doctor will decide the dose (in International Units or “IU”) you will receive. The dose will depend on your individual needs for replacement factor IX therapy and on whether it is used for prevention or treatment of bleeding. Talk to your doctor if you think that your bleeding is not being controlled with the dose you receive.

How often you need an injection will depend on how well the medicine is working for you. Your doctor will perform appropriate laboratory tests to make sure that you have adequate factor IX levels in your blood.

#### **Treatment of bleeding**

The dose of ALPROLIX is calculated depending on your body weight and the factor IX levels to be achieved. The target factor IX levels will depend on the severity and location of the bleeding.

#### **Prevention of bleeding**

If you are using ALPROLIX to prevent bleeding, your doctor will calculate the dose for you.

The usual dose of ALPROLIX is 50 IU per kg of body weight, given once a week or 100 IU per kg of body weight, given once every 10 days. The dose or interval may be adjusted by your doctor. In some cases, especially in younger patients, shorter dosing intervals or higher doses may be necessary.

#### **Use in children and adolescents**

ALPROLIX can be used in children and adolescents of all ages. In children below the age of 12 years, higher doses or more frequent injections may be needed and the usual dose is 50 to 60 IU per kg of body weight, given once every 7 days.

#### **If you use more ALPROLIX than you should**

Tell your doctor as soon as possible. You should always use ALPROLIX exactly as your doctor has told you, check with your doctor, pharmacist or nurse if you are not sure.

#### **If you forget to use ALPROLIX**

Do not take a double dose to make up for a forgotten dose. Take your dose as soon as you remember and then resume your normal dosing schedule. If you are not sure what to do, ask your doctor, pharmacist or nurse.

#### **If you stop using ALPROLIX**

Do not stop using ALPROLIX without consulting your doctor. If you stop using ALPROLIX you may no longer be protected against bleeding or a current bleed may not stop.

If you have any further questions on the use of this medicine, ask your doctor, pharmacist or nurse.

### **4. Possible side effects**

Like all medicines, this medicine can cause side effects, although not everybody gets them.

If severe, sudden allergic reactions (anaphylactic reaction) occur, the injection must be stopped immediately. You must contact your doctor immediately if you experience any of the following symptoms of allergic reactions: swelling of the face, rash, generalised itching, hives, tightness of the chest, difficulty breathing, burning and stinging at the injection site, chills, flushing, headache, general feeling of being unwell, nausea, restlessness, fast heartbeat, and low blood pressure.

For children not previously treated with factor IX medicines, inhibitors (see section 2) may form commonly (up to 1 in 10 patients). If this happens, the medicine may stop working properly and your child may experience persistent bleeding. If this happens, you should contact your doctor immediately.

The following side effects may occur with this medicine.

**Common side effects (may affect up to 1 in 10 people):** headache, mouth numbness or tingling, pain in your side with blood in your urine (obstructive uropathy) and injections site redness. Children not previously treated with factor IX medicines: factor IX inhibitors, hypersensitivity.

**Uncommon side effects (may affect up to 1 in 100 people):** dizziness, taste alteration, bad breath, feeling tired, pain at the injection site, rapid heartbeat, blood in the urine (haematuria), pain in your side (renal colic), low blood pressure, and decreased appetite.

### **Reporting of side effects**

If you get any side effects, talk to your doctor or pharmacist or nurse. This includes any possible side effects not listed in this leaflet. You can also report side effects directly via:

### **United Kingdom**

Yellow Card Scheme

Website: [www.mhra.gov.uk/yellowcard](http://www.mhra.gov.uk/yellowcard)

or search for MHRA Yellow Card in the Google Play or Apple App Store

By reporting side effects you can help provide more information on the safety of this medicine.

## **5. How to store ALPROLIX**

Keep this medicine out of the sight and reach of children.

Do not use this medicine after the expiry date which is stated on the carton and the vial label, listed after "EXP". The expiry date refers to the last day of that month. Do not use this medicine if it has been stored at room temperature for longer than 6 months.

Store in a refrigerator (2 °C – 8 °C). Do not freeze. Store in the original pack in order to protect from light.

Alternatively, ALPROLIX may be stored at room temperature (up to 30 °C) for a single period not exceeding 6 months. Please record on the carton the date that ALPROLIX is removed from the refrigerator and set at room temperature. After storage at room temperature, the product must not be put back in the refrigerator.

Once you have prepared ALPROLIX it should be used right away. If you cannot use the prepared solution immediately, it should be used within 6 hours when stored at room temperature. Do not refrigerate the solution after preparation. Protect the solution from direct sunlight.

The prepared solution will be clear to slightly pearl-like (opalescent) and colourless. Do not use this medicine if you notice that it is cloudy or contains visible particles.

This product is for single use only.

Discard any unused solution appropriately. Do not throw away any medicines via wastewater or household waste. Ask your pharmacist how to throw away medicines you no longer use. These measures will help protect the environment.

## **6. Contents of the pack and other information**

### **What ALPROLIX contains**

#### Powder:

- The active substance is eftrenonacog alfa (recombinant coagulation factor IX, Fc fusion protein). Each vial of ALPROLIX contains nominally 250, 500, 1000, 2000 or 3000 IU eftrenonacog alfa.
- The other ingredients are sucrose, histidine, mannitol, polysorbate 20, sodium hydroxide and hydrochloric acid. If you are on a controlled sodium diet, see section 2.

#### Solvent:

5 mL sodium chloride and water for injections.

### **What ALPROLIX looks like and contents of the pack**

ALPROLIX is provided as a powder and solvent for solution for injection. The powder is a white to off-white powder or cake. The solvent provided for preparation of the solution, is a clear, colourless solution. After preparation, the solution is clear to slightly opalescent and colourless.

Each pack of ALPROLIX contains 1 powder vial, 5 mL solvent in pre-filled syringe, 1 plunger rod, 1 vial adapter, 1 infusion set, 2 alcohol swabs, 2 plasters and 1 gauze pad.

### **Marketing Authorisation Holder and Manufacturer**

Swedish Orphan Biovitrum AB (publ)  
SE-112 76 Stockholm  
Sweden  
Phone: +46 8 697 20 00

**This leaflet was last revised in 02/2021.**

Please turn the leaflet over for section 7. Instructions for preparation and administration.

## 7. Instructions for preparation and administration

The procedure below describes the preparation and administration of ALPROLIX.

ALPROLIX is administered by intravenous (IV) injection after dissolving the powder for injection with the solvent supplied in the pre-filled syringe. ALPROLIX pack contains:

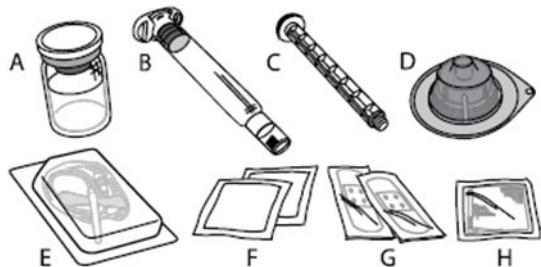

- A) 1 Powder vial
- B) 5 mL Solvent in pre-filled syringe
- C) 1 Plunger rod
- D) 1 Vial adapter
- E) 1 Infusion set
- F) 2 Alcohol swabs
- G) 2 Plasters
- H) 1 Gauze pad

ALPROLIX should not be mixed with other solutions for injection or infusion.

Wash your hands before opening the pack.

### Preparation:

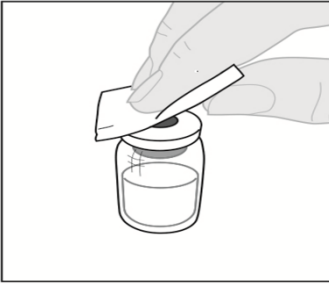
1.	Check the name and strength of the package, to make sure it contains the correct medicine. Check the expiry date on the ALPROLIX carton. Do not use if the product has expired.	
2.	If ALPROLIX has been stored in a refrigerator, allow the vial of ALPROLIX (A) and the syringe with solvent (B) to reach room temperature before use. Do not use external heat.	
3.	Place the vial on a clean flat surface. Remove the plastic flip-top cap from the vial	
4.	Wipe the top of the vial with one of the alcohol swabs (F) provided in the pack and allow to air dry. Do not touch the top of the vial or allow it to touch anything else once wiped.	
5.	Peel back the protective paper lid from the clear plastic vial adapter (D). Do not remove the adapter from its protective cap. Do not touch the inside of the vial adapter package.	

6. Place the vial on a flat surface. Hold the vial adapter in its protective cap and place it squarely over the top of the vial. Press down firmly until the adapter snaps into place on top of the vial, with the adapter spike penetrating the vial stopper.

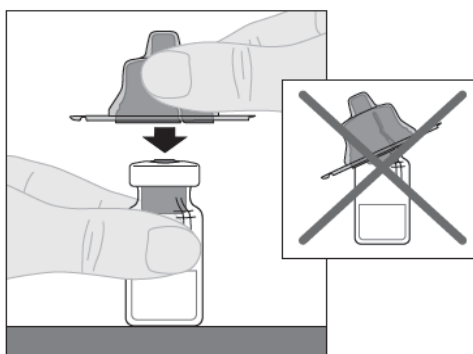

7. Attach the plunger rod (C) to the solvent syringe by inserting the tip of the plunger rod into the opening in the syringe plunger. Turn the plunger rod firmly clockwise until it is securely seated in the syringe plunger.

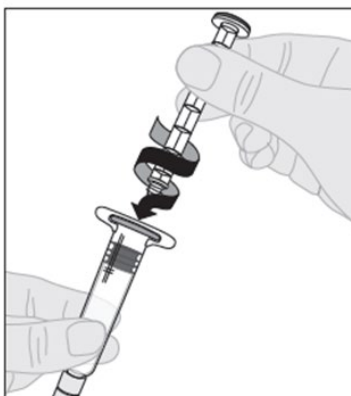

8. Break off the white, tamper-resistant, plastic cap from the solvent syringe by bending the perforation cap until it snaps off. Set the cap aside by placing it with the top down on a flat surface. Do not touch the inside of the cap or the syringe tip.

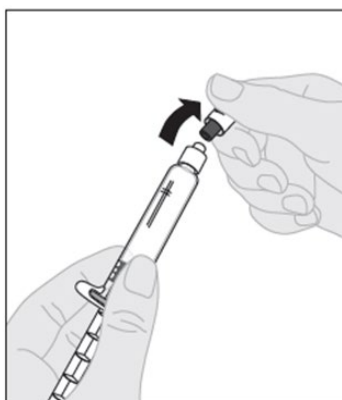

9. Lift the protective cap away from the adapter and discard.

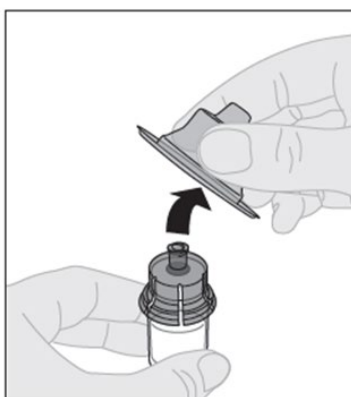

10. Connect the solvent syringe to the vial adapter by inserting the tip of the syringe into the adapter opening. Firmly push and turn the syringe clockwise until it is securely connected.

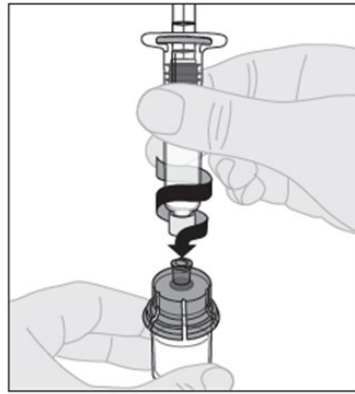

11. Slowly depress the plunger rod to inject all the solvent into the ALPROLIX vial.

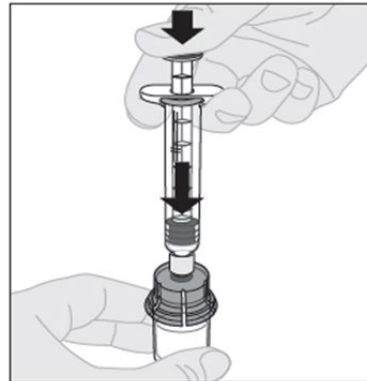

12. With the syringe still connected to the adapter and the plunger rod pressed down, gently swirl the vial until the powder is dissolved. Do not shake.

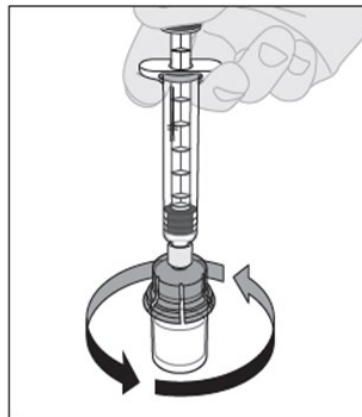

13. The final solution must be inspected visually before administration. The solution should appear clear to slightly pearl-like (opalescent) and colourless. Do not use the solution if cloudy or contains visible particles.

14. Ensuring that the syringe plunger rod is still fully pressed down, invert the vial. Slowly pull on the plunger rod to draw back all the solution through the vial adapter into the syringe.

Note: If you use more than one vial of ALPROLIX per injection, each vial should be prepared separately as per the previous instructions (steps 1 to 13) and the solvent syringe should be removed, leaving the vial adapter in place. A single large luer lock syringe may be used to draw back the prepared contents of each of the individual vials.

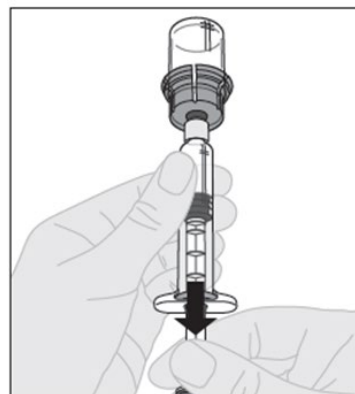



15. Detach the syringe from the vial adapter by gently pulling and turning the vial counterclockwise.

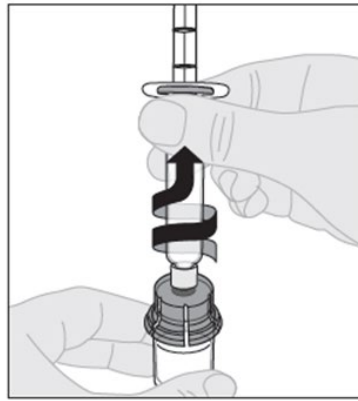

16. Discard the vial and the adapter.

Note: If the solution is not to be used immediately, the syringe cap should be carefully put back on the syringe tip. Do not touch the syringe tip or the inside of the cap.

After preparation, ALPROLIX can be stored at room temperature for up to 6 hours before administration. After this time, the prepared ALPROLIX should be discarded. Protect from direct sunlight.

### Administration (Intravenous Injection):

ALPROLIX should be administered using the infusion set (E) provided in this pack.

1. Open the infusion set package and remove the cap at the end of the tubing. Attach the syringe with the prepared ALPROLIX solution to the end of the infusion set tubing by turning clockwise.

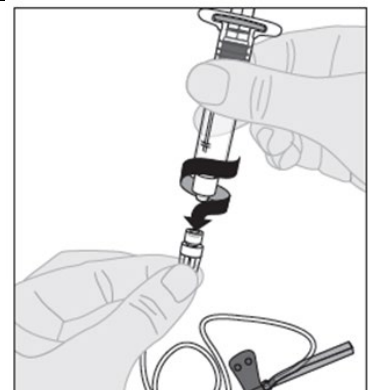

2. If needed apply a tourniquet and prepare the injection site by wiping the skin well with the other alcohol swab provided in the pack.

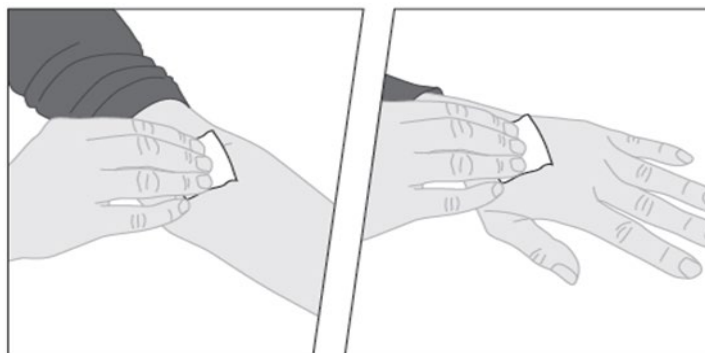

3. Remove any air in the infusion set tubing by slowly depressing on the plunger rod until liquid has reached the infusion set needle. Do not push the solution through the needle. Remove the clear plastic protective cover from the needle.

4. Insert the infusion set needle into a vein as instructed by your doctor or nurse and remove the tourniquet. If preferred, you may use one of the plasters (G) provided in the pack to hold the plastic wings of the needle in place at the injection site. The prepared product should be injected intravenously over several minutes. Your doctor may change your recommended injection rate to make it more comfortable for you.

5. After completing the injection and removing the needle, you should fold over the needle protector and snap it over the needle.

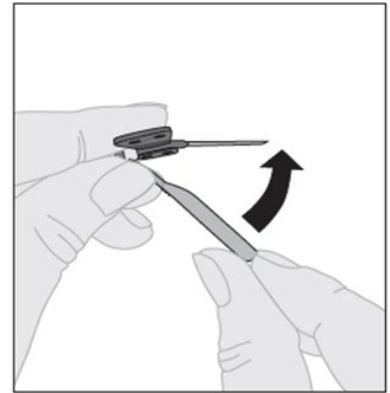

6. Please safely dispose of the used needle, any unused solution, the syringe and the empty vial in an appropriate medical waste container as these materials may hurt others if not disposed of properly. Do not reuse equipment.